

Built in & Free standing wine cooler

Model: ZS-A150

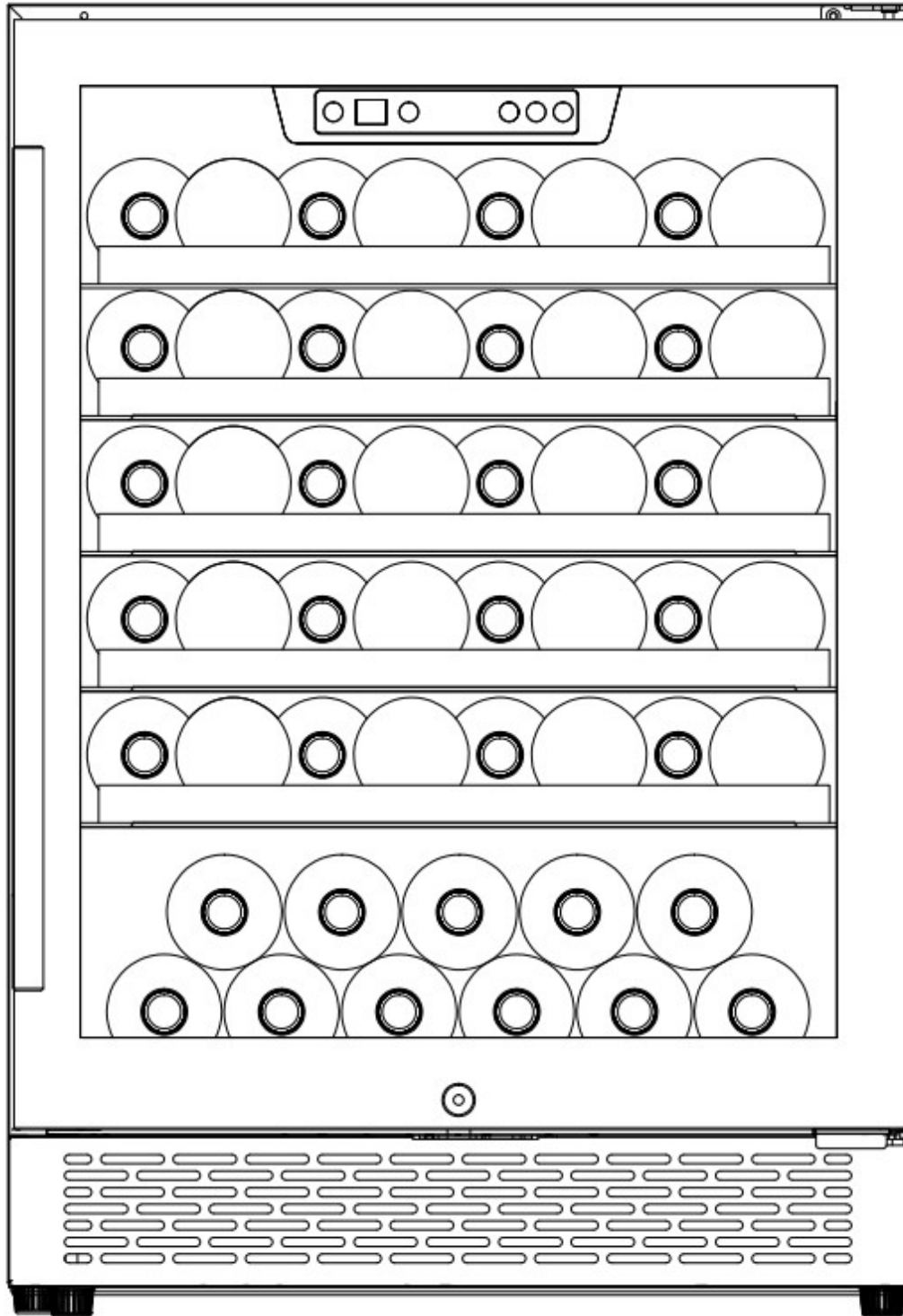

● Wine Cooler Package Contents

- 1pc Instruction Manual
- 5pcs Standard Shelves
- 2pcs Keys

● Important Safety Instructions

WARNING: To reduce the risk of fire, electric shock or personal injury, unplug or disconnect the appliance from the power supply before servicing.

- Read all instructions before using the wine cooler.
- **DANGER:** Risk of child becoming trapped in new wine cooler, old wine cooler/refrigeration unit, or large boxes. Junked or abandoned appliances, boxes and other containers are still dangerous, even if they will just in the garage for a few days.
- Never allow children to operate, play with, crawl inside the appliance.
- Never clean appliance parts with flammable fluids. The fumes can create a fire hazard or explosion.
- Do not store in the vicinity of any other appliance. Do not store near gasoline or any other flammable vapors. The fumes can create a fire hazard or explosion.

● Proper Disposal

An empty cooler is an extremely dangerous attraction to children. If you are getting rid of your old cooler, pls follow the instructions in the Child Entrapment Warning.

● Child Entrapment Warning

Risk of child entrapment. Before you throw away your old cooler or freezer:

1. Take of the doors.
2. Leave the shelves in place so that children may not easily climb inside.

● Before Using Your Wine Cooler

- Remove the exterior and interior packaging.
- Before connecting the wine cooler to power source, let it stand upright for approximately 2 hours. This will reduce the possibility of a malfunction in the cooling system from handling during transportation.
- Clean the interior surface with lukewarm water using a soft cloth.

● HOW TO BUILT IN

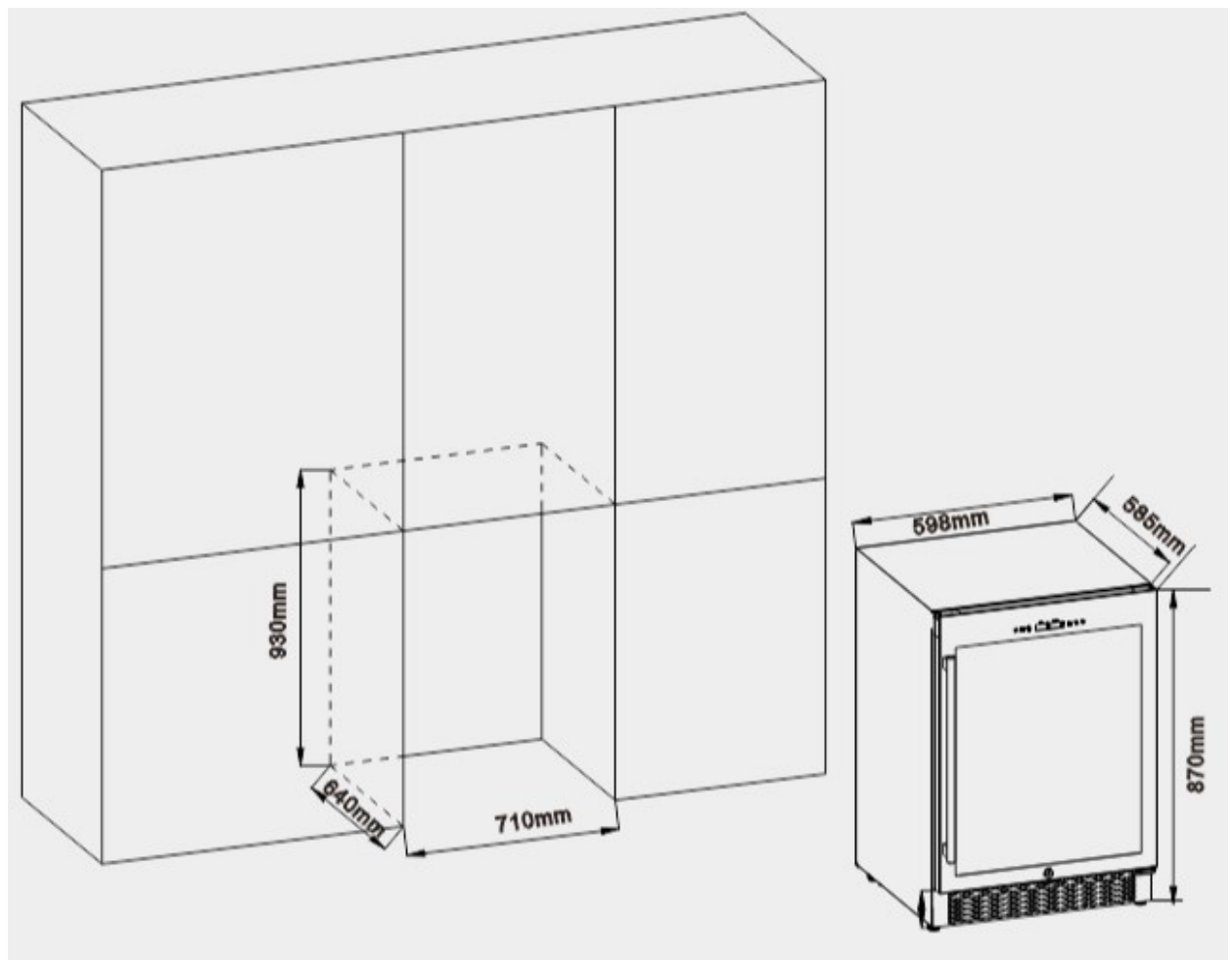

● Operation For Temperature

Temperature Range: 5-20°C

41-68°F

● Operation Panel





The setting should be operate in the control panel.

1. Functions of each key in the operation panel.

(1).Up 

Used to raise (warm)the set temperature by 1°C or 1°F . When the screen is flashing, press it once, the temperature setting is up by 1°C or 1°F , the highest setting temperature is 20°C(68°F) . Stop to press any button for 5 seconds, then the number stop flashing to show the actual temperature of the cabinet.

Set the desired temperature using  or  .

(2).Temperature Display 

The LED display will show the setting temperature when “flash”; Display will show the temperature for the actual temperature of the cabinet when normal.

(3).Down 

Used to lower (cool) the set temperature by 1°C or 1°F . When the screen is flashing, press it once, the temperature setting is down by 1°C or 1°F , the lowest setting temperature is 5°C (41°F) . Stop to press any button for 5 seconds, then the number stop flashing to show the actual temperature of the cabinet.



(4). Temperature unlock key 

Tap this key to unlock the temperature. After unlocking, you can use the temperature up/down keys to adjust the temperature. After the temperature adjustment is completed, the temperature will be automatically locked after flashing.

(5).°C/°F Switch key/light switch key 

Touch this button to control the LED light switch, press for 3 seconds to switch °C/°F.

(6).Power 

To control the appliance turn on/off. To turn off the appliance, touch the  button and hold for at least 5 seconds. Press  again, turn on the appliance.

The LED readout will show the original temperature set previously when restart the appliance or reconnect after power cuts .

2. There is automatic storage memory when power off in this wine cooler, that means the setting temperature is memorized automatically even in power off, so the setting temperature is the same as last setting when the wine cooler is running again.

3. Defrosting

The unit defrosts automatically.

The evaporator behind the rear wall of the unit defrosts automatically. The condensate collects in the drainage channel behind the rear wall of the unit, and flows through the drainage hole into the drip tray by the compressor where it evaporates. When the wine cooler run for some time, the wine cooler will enter to defrosting, the compressor stop running and the fan will keep running. The temperature will up to about 5°C when defrosting, then keep on running normally; It takes more time for the temperature to come up to 5°C when the setting temperature is low(for example the setting temperature is -2°C), and there are full of wines in the cabinet, and this is not a breakdown.

● Points Of Intentions

1. The vent grill outside the cabinet is the heat dissipation way of cooling system in wine cooler, please prevent anything from covering or blocking, or it will make the wine cooler overheating and cause damage to product.
2. Please prevent blocking cooling fan, or it will make the temperature too high or uneven in the cabinet.
3. Please close the door tightly, it will cause the refrigerating inefficiency, overflow in the cabinet, or unnormal temperature once the door is not closed tightly for a long time.
4. Please shut off the power, and open the door to let the cabinet dry enough if you don't use the wine cooler for a long time.
5. This product is not suitable for areas with an altitude of 2000 meters.

●Product Parameters

1. Voltage: 230V / 50Hz
2. Rated power: 70W
3. Climate type: ST/SN/N

●Layout And Storage

Your cabinet was designed to store a maximum number of bottles securely. We recommend that you observe the below tips to optimize loading.

- Remove tape from shelves once unit is stable and ready for storage.
- Disperse the bottles evenly to avoid concentrating weight in one place. Bottles must not touch either the back of the cabinet.
- Make sure that the bottles are not all grouped together either at the top or bottom of the cabinet.
- Only pull out one shelf at a time. Never attempt to pull more than one.
- Maximum weight capacity per shelf is 55lbs
- You can crease your wine cooler storage capacity by removing shelves and stacking bottles on top of one another. Do not stack more than 3 rows of bottles per shelf.

●Care Maintenance

Cleaning your wine cooler

- Turn off the power, unplug the appliance, and remove all items including shelves and rack.
- Wash the inside surfaces with a warm water and baking soda solution. The solution should be about 2 tablespoons of baking soda to a pint of water.
- Wash the shelves with a mild detergent solution.
- Wring excess water out of the sponge or cloth when cleaning any area of the controls.
- Wash the outside cabinet with warm water and mild liquid detergent. Rinse well and wipe dry with a clean soft cloth.

Power Failure

- Most power failures are corrected within a few hours should not affect the temperature of your appliance if you minimize the number of times the door is opened. If the power is going to be off for a longer period of time, you need to take other measures to protect your contents.
- If the unit is unplugged, loses power, or is turned off you must wait 3 to 5 minutes before restarting. Attempting to restart the wine cooler before this time has elapsed may prevent the wine cooler from starting..

Vacation Time

- Short holidays: You may leave the Wine Cooler powered on and unattended for absences of less than three weeks.
- Long absences: If the appliance will not be used for several months, remove all items, turn off the appliance and unplug. Clean and dry the interior thoroughly. To prevent odour and mold growth, leave the door open

slightly : blocking it open if necessary.

Moving Your Wine Cooler

- Remove all items.
- Securely tape down all loose items (shelves) inside your appliance.
- Turn the adjustable leg up to the base to avoid damage.
- Tape the door shut.
- Be sure the appliance stays secure in the upright position during transportation. Also protect outside of appliance with a blanket, or similar item.

Energy Saving Tips

- The Wine Cooler should be located in the coolest area of the room, away from heat producing appliances, and out of the direct sunlight.
- Ensure that the unit is adequately ventilated. Never cover air vents.
- Only open the door for as long as necessary.

● Troubleshooting Guide

Problems with Your Wine Cooler

Many common issues with your wine cooler can be solved very easily. Try the troubleshooting tips below should you experience any problems.

PROBLEM	POSSIBLE CAUSE
Wine Cooler does not operate.	Not plugged in. The appliance is turned off. The circuit breaker tripped or a blown fuse.
Wine Cooler is not cold enough.	Check the temperature control setting. External environment may require a higher setting. The door is opened too often. The door is not closed completely. The door gasket does not seal properly
Turns on and off frequently	The room temperature is hotter than normal. A large amount of contents has been added to the Wine Cooler. The door is open too often The door is not closed completely. The temperature control is not set correctly. The door gasket does not seal properly.

The light does not work.	Not plugged in. The circuit breaker tripped or a blown fuse. The light switch is "OFF".
Vibrations	Check to assure that the Wine Cooler is level.
The door will not close properly.	The Wine Cooler is not level. The door was reversed and not properly installed. The gasket is dirty. The shelves are out of position.
The Wine Cooler seems to make too much noise	The rattling noise may come from the flow of the refrigerant, which is normal. As each cycle ends, you may hear gurgling sounds caused by the flow of refrigerant in your Wine Cooler. Contraction and expansion of the inside walls may cause popping and crackling noises. The Wine Cooler is not level.

Sensor Trouble shooting

Fault situation	Reason	Solution
Fault code E1	short circuit	Please contact customer service before returning to our service center for inspection/repair.
Fault code E0	open circuit	Please contact customer service before returning to our service center for inspection/repair
Fault code E5	Communication failure display	Please contact customer service before returning to our service center for inspection/repair

●Warranty

This product has been manufactured by Zhongshan Josoo Electric Appliance Co.,Ltd.

The warranty does not apply to damage resulting from abuse, accident, natural disaster, loss of electrical power to the product for any reason, alteration, outdoor use, improper installation, and improper operation, repair or service of the product by anyone other than an authorized by us, service agency or representative.